

Modeling Switched Behavior with Hybrid Bond Graph : Application to a Tank System

Slim TRIKI¹, Taher MEKKI¹ and Anas KAMOUN¹

¹ Research Unit on Renewable Energies and Electric Vehicles (RELEV), University of Sfax
Sfax Engineering School (ENIS), Tunisia

Abstract

Different approaches have been used in the development of system models. In addition, modeling and simulation approaches are essential for design, analysis, control, and diagnosis of complex systems. This work presents a Simulink model for systems with mixed continuous and discrete behaviors. The model simulated was developed using the bond graph methodology and we model hybrid systems using hybrid bond graphs (HBGs), that incorporates local switching functions that enable the reconfiguration of energy flow paths. This approach has been implemented as a software tool called the Modeling and Transformation of HBGs for Simulation (MOTHS) tool suite which incorporates a model translator that create Simulink models. Simulation model of a three-tank system that includes a switching component was developed using the bond graph methodology, and MoTHS software were used to build a Simulink model of the dynamic behavior.

Keywords: Simulation, hybrid system, bond graph, Simulink model

1. Introduction

Wherever continuous and discrete dynamics interact, hybrid systems arise. To capture the evolution of these systems, mathematical models are needed that combine in one way or another, the dynamics of the continuous parts of the system with the dynamics of the logic and discrete parts. In particular, physical systems with switching phenomena are a class of a hybrid system [1]. When switching occurs, the system may change its mode of operation. If a system has n switching states, then it gives rise to 2^n possible operating modes. One way to represent mode switching is to generate 2^n sets of differential-algebraic equations (DAEs). Each set describes continuous behaviour of system in that particular mode. In practice, not all modes are practically realizable. This work presents the simulation of a didactic and simple hybrid tank system. The model simulated was developed using the bond graph methodology, and MATLAB and MoTHS software were used to obtain the dynamic behavior of the tank system.

2. Hybrid system and switched phenomena

Appropriate models for hybrid systems are often obtained by adding new dynamical phenomena to the classical description formats of the mono-disciplinary research areas. Indeed, continuous models represented by differential or difference equations, as adopted by the dynamics and control community, have to be extended to be suitable for describing hybrid systems. On the other hand, the discrete models used in computer science, such as automata or finite-state machines, need to be extended by concepts like time, clocks, and continuous evolution in order to capture the mixed discrete and continuous evolution in hybrid systems. Here we will describe the phenomena one has to add to the continuous models based on the differential equations:

$$\dot{x}(t) = f(x(t)) \quad (1)$$

In general, four new phenomena that are typical for hybrid systems are required to extend the dynamics of purely continuous systems as in (1):

- autonomous switching of the dynamics;
- autonomous state jumps;
- controlled switching of the dynamics;
- controlled state jumps.

We will focus in this paper to the autonomous and controlled switching of the dynamics and the reader could refer to [2] for more detail about others phenomenon.

Switching phenomena reflects the fact that the vector field f that occurs in (1) is changed discontinuously. The switching may be invoked by a clock if the vector field f depends explicitly on the time t :

$$\dot{x}(t) = f(x(t), t) \quad (2)$$

For instance, if periodic switching between two different modes of operation is used with period $2T$, we would have:

$$\dot{x}(t) = f(x(t), t) = \begin{cases} f_1(x(t)), & \text{if } t \in [2kT, (2k+1)T[\text{ for } k \in \mathbb{N} \\ f_2(x(t)), & \text{if } t \in [(2k+1)T, (2k+2)T[\text{ for } k \in \mathbb{N} \end{cases} \quad (3)$$

This is an example of *time-driven switching*. The switching can also be invoked when the continuous state x reaches some switching set S . As the situation $x(t) \in S$ is considered to be a state event, this kind of switching is said to be *event-driven*.

Consider the three coupled tanks depicted in Fig. 1 which originally has been adopted as a benchmark problem for fault detection algorithms and reconfigurable control [3, 4]. The tanks systems are used widely in many articles as a good case study or experimental system, to impose the proposed methods for identification, fault detection, or control purposes [5-7]. There are varieties of tanks system configurations; the configuration adopted in this work is three interacting tanks system, in which system consists three identical tanks that are connected by pipes which can be controlled by different valves. Water can be filled into the left and right tanks using two identical pumps. Measurements available from the process are the continuous water levels $h_i(t)$ of each tank. The connection pipe, with valve R_{12} (res. R_{23}), between the tank 1 and 2 (res. 2 and 3) is placed at a height of 0.5 (res. 0.7).

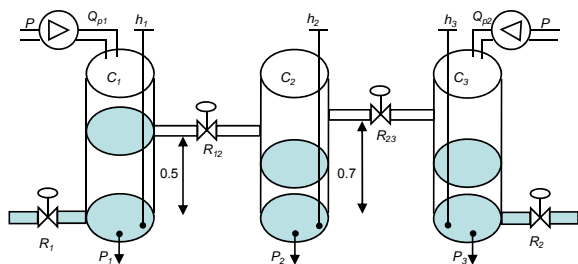

Fig. 1. Hybrid tank system

This example of hybrid tank system illustrates situations in which the dynamics of a process changes in dependence upon the state (liquid level). For example, the tank C_1 is filled by the pump P , which is assumed to deliver a constant flow Q_{P1} , and emptied by two outlet pipes, whose outflows $Q_{R1}(t)$ and $Q_{R12}(t)$ depend upon the level $h_1(t)$ and $h_2(t)$. Then, the flow $Q_{R12}(t)$ vanishes if the liquid level is below the threshold 0.5 given by the position of the upper pipe R_{12} . However, depending whether the level $h_1(t)$ and/or $h_2(t)$ is above or below this threshold, four configuration of the dynamical properties of the tank C_1 are possible:

$$\dot{h}_1(t) = \begin{cases} \frac{1}{A}(Q_{P1} - Q_{R1}) & \text{if } (h_1(t) < 0.5 \ \& \ h_2(t) < 0.5) \\ \frac{1}{A}(Q_{P1} - Q_{R1} - Q_{R12}) & \text{if } (h_1(t) \geq 0.5 \ \& \ h_2(t) < 0.5) \\ \frac{1}{A}(Q_{P1} - Q_{R1} + Q_{R12}) & \text{if } (h_1(t) < 0.5 \ \& \ h_2(t) \geq 0.5) \\ \frac{1}{A}(Q_{P1} - Q_{R1} - \text{sign}(\Delta h)Q_{R12}) & \text{if } (h_1(t) \geq 0.5 \ \& \ h_2(t) \geq 0.5) \end{cases} \quad (4)$$

Where A is the area of the tank and the different flows used in the equation above can be obtained by TORICELLY's law.

3. Bond graph model of switching system

Modeling and simulation of switching systems using a bond graph is one of the topics of research and various models have been proposed (see, for instance, [8-12]). To include discrete transition and modeling switching phenomena, additional mechanisms are introduced into the continuous BG language. We use switched junctions proposed by Mosterman and Biswas [12], where each junction in the bond graph may be switched *on* (activated) and *off* (deactivated). An activated junction behaves like a conventional BG junction. All the bonds incident on a junction turned off are made inactive, and hence do not play any part in the system dynamics. Note that activating or deactivating junctions affect the behavior of adjoining junctions. Those junction switching function are implemented as a finite state automaton *control specification* (CSPEC). The Finite State Automaton (FSA) may have several states, and each state maps to either the *off* mode or the *on* mode of the junction. Mode transitions defined solely by external controller signals define *controlled switching*, and those expressed by internal variables crossing boundary values define *autonomous switching*. The overall mode of the system is determined by a parallel composition of modes of the individual switched junctions. Formally, Hybrid Bond Graphs (HBG) can be defined as a triple: $HBG = \{BG, M, a\}$, where BG is the Bond Graph model, $M = \{M_1, M_2, \dots, M_k\}$ is a set of finite state of automata, and a is the mapping between each M , and a junction in the bond graph. Each M , is a finite state automaton of the type described above, with an output function that maps each state of M , to either *on* or *off*. A system mode change is defined by one or more junction automata changing state, and this result in a new bond graph model.

The hybrid tank system, shown in Fig. 1, consists of three tanks which are modeled as linear fluid capacities, pipes that connect the tanks and represent the outflow from the system are modeled as linear resistances to fluid flow, and flow sources into the tanks modeled as idealized flow sources in the bond graph framework. The hybrid bond graph model of the system is illustrated in Fig. 2. The two

flow sources into tanks 1 and 3 are indicated by Sf_1 and Sf_2 , respectively, the tank capacities are shown as C_1 , C_2 and C_3 , and the pipes are modeled by resistances R_1 , R_{12} , R_{23} and R_2 . Pumps and valves are modeled by controlled junctions, which are shown in the figure as junctions with subscripts (1_1 , 1_2 , 1_5 , and 1_6). The control signals for turning these junctions *on* and *off* are generated by the finite state automata in Fig. 2. For autonomous transitions in the system, also modeled by controlled junctions, the transition conditions computed from system variables (e.g., see the transition conditions for junctions 1_3 and 1_4). A mode in the system is defined by the state of the six controlled junctions in the hybrid bond graph model. Therefore, theoretically the system can be in 2^6 different modes. In the rest of this paper, we assume that all valves are always opened.

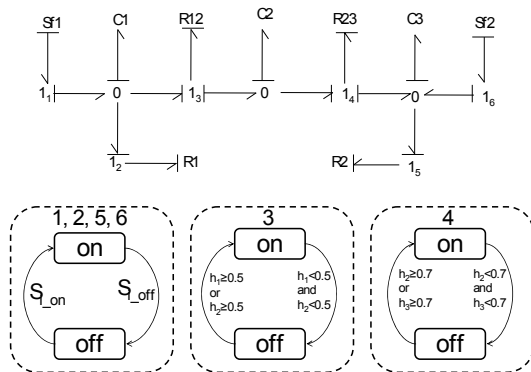

Fig. 2. Hybrid tank system

4. From hybrid bond graph to Matlab-Simulink model: Example of the hybrid tank

Turning source elements *on* and *off* represent changes in the system configuration, and they are modeled as controlled events in the system (see figure (3.a)). Autonomous mode transitions also occur in the system as shown in acausal hybrid bond graph of the three-tank system of figure (3.a). For example, when the fluid level in tank 1 reaches the height at which pipe R_{12} is placed, a flow is initiated in pipe R_{12} . This represents a configuration change. However, depending whether the fluid level in tank 1 and/or tank 2 is above or below the level of the pipe, the four configurations described in previous paragraph are possible. These are modeled using switched junctions and modulated flow sources (see figure (3.b)). In this case, the transition conditions are a function of other physical variables of the system. The representation of pipes R_{12} and R_{23} is not easy. Consider

the pipe R_{12} connecting tanks 1 and 2. The four possible configurations can be expressed in terms of the following expressions:

- i. $(h_{left} < H \wedge h_{right} < H)$,
- ii. $(h_{left} \geq H \wedge h_{right} < H)$,
- iii. $(h_{left} < H \wedge h_{right} \geq H)$, and
- iv. $(h_{left} \geq H \wedge h_{right} \geq H)$.

Where h_{left} is the level of fluid in tank 1, h_{right} is the level of fluid in tank 2, and H is the height at which the pipe is located ($H=0.5$ for pipe R_{12}). Configuration (i), see figure (3.c), implies that the tanks are not connected, and the pipe is inactive. Configuration (iv), where both fluid levels are above the pipe height, can be modeled using the traditional pressure-flow relation, i.e., flow is proportional to difference in pressures. In configuration (ii), where the left tank level is above the pipe but the right tank level is not, the pipe acts as an outflow pipe for the left tank but as flow source for the right tank. This situation is modeled using a modulated flow source, where the modulating factor is the flow through the 1-junction representing the pipe R_{12} . The configuration (iii) is similar to configuration (ii) but the situation in the left and right tanks are reversed.

We have implemented our modeling and simulation approach as the Modeling and Transformation of HBGs for Simulation (MoTHS) tool suite. The MoTHS tool suite consists of a graphical modeling language for building hierarchical, component-based HBG models [13] in the Generic Modeling Environment (GME) and a set of model translators (or interpreters) that automatically convert these HBGs into block diagram-based simulation models for selected simulation tools. In this HBG framework, the internal structure of a component model is defined by an HBG fragment with a corresponding set of functions to define the CSPECs of the switching junctions. CSPECs are formulated as simplified two-state finite automata, with one state mapping to the *on* mode and the other to the *off* mode of the junction. As such, the modeler needs only to specify the transition guards going from the *on* to *off* mode (the off-guard) and the *off* to *on* mode (the on-guard). These functions can be specified using effort, flow, and signal variables within the model, so we can capture both controlled and autonomous mode transitions. The MoTHS bond graph model of the tank system is given in Fig. 4.

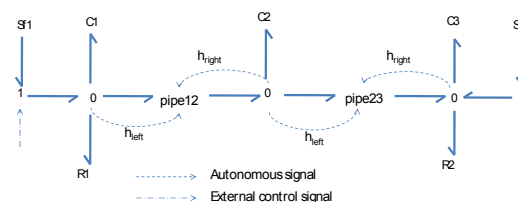

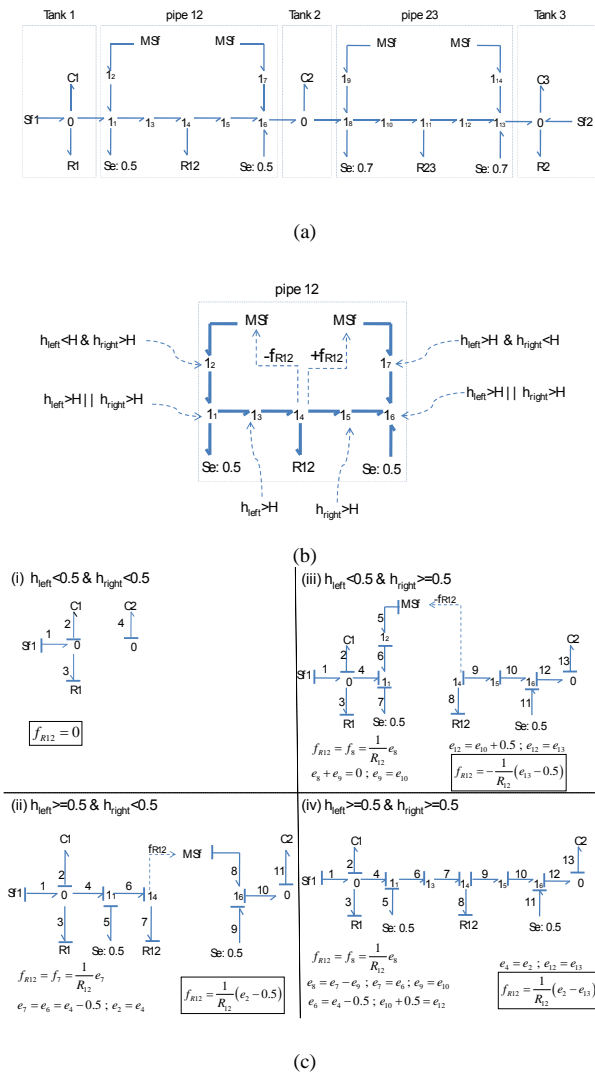

Fig. 3. Hybrid Bond Graph of the tank system (a), and the pipe R12 (b), (c)

As shown in figure (4.b), the function *Pump_u1* describe the inlet flow source as $Q_{P1} = u_1 \cdot \bar{q}$ where u_1 is the flow velocity and \bar{q} is the flow constant of the pump1. The pump1 is switched *on* by changing the status of the function *Pump_Sw* to *on* at time $t = t_{10}$. This indicates that the on-guard for the switching 1-junction *I_left* is the signal “*Pump_Sw*” and the off-guard is “!*Pump_Sw*”. Hence, junction *I_left* switches *on* when “*Pump_Sw*” evaluates to true, and it switches *off* when “!*Pump_Sw*” evaluates to true. The 1-junction *I_right*, which defines the pipe flow between tank 1 and 2, is controlled by the decision function *AboveRight* or the decision signal

RightInFlow. Note that, *Decision Functions* is a MoTHS-specific element that uses logical expressions to convert continuous measurement signals into boolean values, which can then be used within on or off-guards for switching junctions. In our case, *AboveRight* is *on* when the fluid level in tank 1 reaches the height at which pipe *R12* is placed (see the bottom right pane of the GME window in the Figure (4.b)). The decision signal *RightInFlow* is *on* when the level in tank 2 is above the pipe *R12* but the level tank 1 is not.

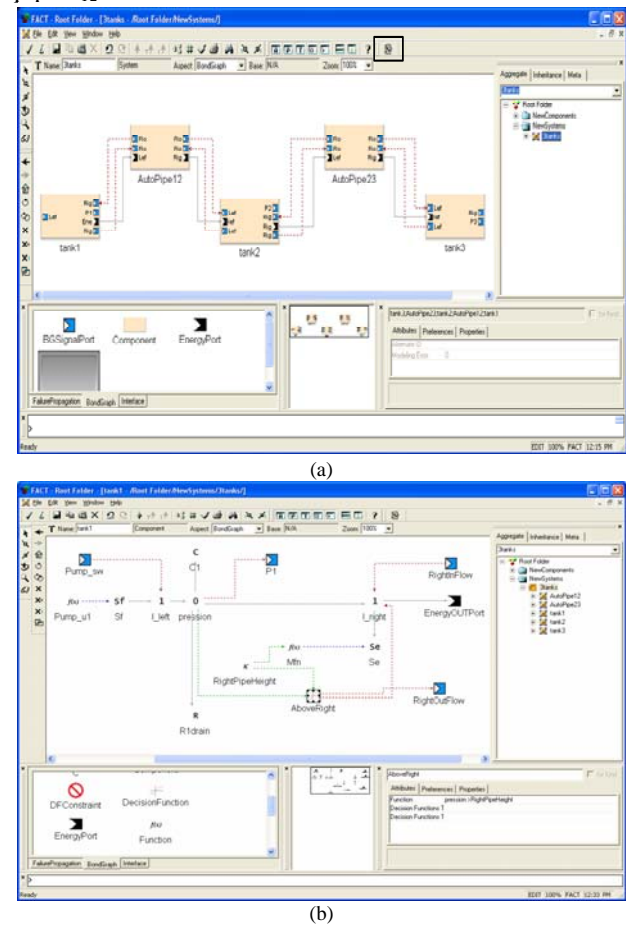

Fig. 4. Screenshot of the GME editor for MoTHS (a) of the three tanks Hybrid Bond Graph, (b) of the tank 1.

By using MoTHS to create the hybrid bond graph we were able to generate a Simulink model quickly and directly. An interpreter, which operates on the HBG models created in MoTHS, generates the simulation model automatically [14]. The interpreter operates in two steps: (i) the transformation of the HBG model to an implementation-independent Intermediate Block Diagram model (IBD), and (ii) the conversion of the IBD model to simulation artifacts implemented in Matlab simulation environment. In Figure (4.a), the interpreter is invoked by clicking the

icon that is enclosed within the black rectangle. The complete model of figure (4.a) was then fed into an interpreter which converted it into a ready to use Simulink model as shown in Fig. 5. MATLAB 7.0 is used to simulate the model of the tank system. The parameters of the system are all fixed equal to one ($R_1=R_{12}=R_{23}=R_2=1\text{m}^{-1}\text{s}^{-1}$ and $C_1=C_2=C_3=1\text{kg}^{-1}\text{m}^4\text{s}^2$). The model was simulated using a fixed-step simulation with sample period of 0.01s and the simulation model was run for 10 seconds of simulation time. The control configuration for the three tank system is as follow:

1. Pump 1 and Pump 2 are switched *on* and *off* at different time intervals
 Pump 1: Open at $t_{10} = 1\text{s}$, $Q_{p1}=1$
 Pump 2: Open at $t_{20} = 3\text{s}$, $Q_{p2}=0.5$
2. The two top pipes connecting the three tanks are always open as well as the drain valves.
3. Initially all tank are empty.

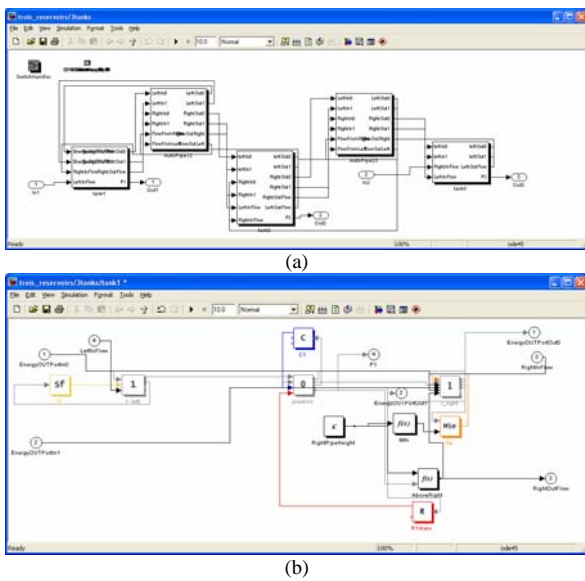

Fig. 5. Screenshot of the GME editor for MoTHS (a) of the three tanks Hybrid Bond Graph, (b) of the tank 1.

Simulation results of the levels h_1 , h_2 , h_3 and input flows sources Q_{p1} , Q_{p2} are shown in Fig. 6. The plots show transient response of the level in tank 1 immediately after switching ON the pump 1 at time $t_{10} = 1\text{s}$. The system is then at configuration mode (i). From the bond graph, with integral causality, of figure (3.c) the constitutive relation of the junction 0, associated to the R-element, leads to:

$$\begin{cases} e_1 = e_2 = e_3 \\ f_2 = Sf_1 - f_3 \end{cases} \quad (5)$$

By constitutive equation of C_1 and R_1 element, $\dot{e}_2 = \frac{1}{C_1} f_2$ and $f_3 = \frac{1}{R_1} e_3$. Hence, the second term of (5) becomes:

$$\dot{e}_2 = \frac{1}{C_1} \left(Sf_1 - \frac{1}{R_1} e_2 \right) \quad (6)$$

So, in configuration mode (i) the tank 1 react as a system of first order with a transfer function:

$$\frac{E_2(s)}{S_{f1}(s)} = \frac{1}{1+s} \quad (7)$$

From the inverse Laplace of (7), the level in tank 1 can be written as:

$$e_2(t) = 1 - e^{-(t-t_{10})} \quad (8)$$

We can deduce from (8) that the liquid in tank 1 reaches the level 0.5 at time $t_1 = -\ln(0.5) + t_{10} = 1.7\text{s}$ instant when the pipe R_{12} become conducting. This result confirms the plot shown in Fig. 6, where the system configuration change to mode (ii) at time $t_1 = 1.7\text{s}$. Note that at time t_1 the pump 2 is still OFF and tank 3 is empty. We can remark, also, that the plot of the level in tank 2 show a transient response immediately at time t_1 .

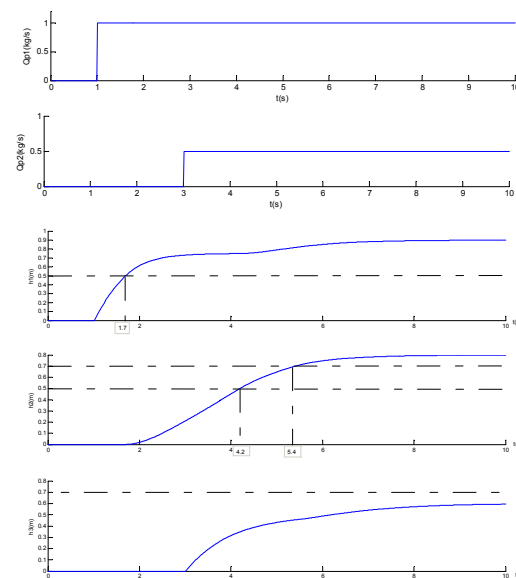

Fig. 6. Waveforms of the input/output bond graph model simulation

From the HBG model in configuration mode (ii), illustrated in figure (3.c), the constitutive relations of

junction 0, 1₁, 1₄, 1₆ and 0 are given by the following equations:

$$\begin{cases} e_2 = e_1 = e_3 = e_4 \\ f_2 = Sf_1 - f_3 - f_4 \end{cases} \quad (9)$$

$$\begin{cases} f_6 = f_5 = f_4 \\ e_6 = e_4 - 0.5 \end{cases} \quad (10)$$

$$\begin{cases} f_6 = f_7 \\ e_6 = e_7 \end{cases} \quad (11)$$

$$\begin{cases} f_{10} = f_8 = f_9 = f_7 \\ e_{10} = e_8 + 0.5 \end{cases} \quad (12)$$

$$\begin{cases} e_{11} = e_{10} \\ f_{11} = f_{10} \end{cases} \quad (13)$$

The constitutive equation of C_1 , R_1 , R_{12} and C_2 leads to $\dot{e}_2 = \frac{1}{C_1} f_2$, $f_3 = \frac{1}{R_1} e_3$, $f_7 = \frac{1}{R_{12}} e_7$ and $\dot{e}_{11} = \frac{1}{C_2} f_{11}$. By substitution of unknown variables in equations (9) to (13), one obtains the state space representation of the measured effort in tank 1 and 2 as follow:

$$\begin{cases} \dot{e}_2 = \frac{1}{C_1} \left(Sf_1 - \left(\frac{1}{R_1} + \frac{1}{R_{12}} \right) e_2 + \frac{1}{R_{12}} 0.5 \right) \\ \dot{e}_{11} = \frac{1}{C_2} \frac{1}{R_{12}} (e_2 - 0.5) \end{cases} \quad (14)$$

Since $C_1=R_1=R_{12}=C_2=1$, equation (14) can be written as:

$$\begin{cases} \dot{e}_2 = Sf_1 - 2e_2 + 0.5 \\ \dot{e}_{11} = (e_2 - 0.5) \end{cases} \quad (15)$$

By applying Laplace transformation, equation (15) becomes:

$$\begin{cases} s.E_2(s) - 0.5 = \frac{1}{s} - 2E_2(s) + \frac{0.5}{s} \\ s.E_{11}(s) = \left(E_2(s) - \frac{0.5}{s} \right) \end{cases} \Leftrightarrow \begin{cases} E_2(s) = \frac{(3+s)}{2s(s+2)} \\ E_{11}(s) = \frac{1}{2s^2(s+2)} \end{cases} \quad (16)$$

So, the level in tank 2 can be determined from the inverse Laplace of the equation (16) and can be written as:

$$e_{11}(t) = \frac{1}{4}t - \frac{1}{8} + \frac{1}{8}e^{-2t} \quad (17)$$

With taken into account the delay, we can deduce from (17) that the liquid in tank 2 reaches the level 0.5 at time $t_2 = 2.5 + t_1 = 4.2s$ instant when the system configuration change to the mode (iv). Hence, simulation results demonstrate the validity of the dynamic behavior of the switched tank system.

5. Conclusions

In this paper, we have presented an approach for modeling and simulation of a system with switching behaviors using hybrid bond graph. An example of three-tank system was used to illustrate this approach. The use of the MoTHS tool suite was very helpful to build Matlab-Simulink executable model. Simulation results demonstrated the validity of the dynamic behavior of the switched tank system.

References

- [1] H. Guéguen et J. Zaytoon, Vérification des systèmes hybrides : état de l'art, Hermès/Lavoisier, APII-JESA, 38(1-2):145-175, 2004.
- [2] M. S. Branicky. Introduction to hybrid systems. In D. Hristu-Varsakelis and W. S. Levine, eds., Handbook of Networked and Embedded Control Systems, pp. 91–116. Birkhäuser, Boston, MA, 2005.
- [3] J. Lunze, et al., “Tank Control Reconfiguration,” Control of Complex Systems: K.J. Aström, P. Albertos, M. Blanke, A. Isidori, W. Schaufelberger, R. Sanz (Eds.), pp. 241-283. Springer-Verlag, 2001.
- [4] B. Heiming, J. Lunze, “Definition of the Three-Tank Benchmark Problem for Controller Reconfiguration,” Proc. of the European Control Conf., Karlsruhe, Germany, 1999.
- [5] S. Maruthai, S.J. Gunna, H.R. Ranganathan, “Integrated fuzzy logic based intelligent control of three-tank system,” Serbian J. of Electr. Eng., vol. 6, pp. 1-14, 2009.
- [6] Jian Wu, G. Biswas, S. Abdelwahed, E. Manders, “A hybrid control system design and implementation for a three-tank testbed,” Proc. of IEEE Conf. on Control Appl., pp. 645-650, August 2005.
- [7] T. Mekki, S. Triki and A. Kamoun, “Diagnosis of switching system using hybrid bond graph”, International Journal of Computer Science Issues-IJCSI Volume 10, Issue 1, pp. 112-119, January 2013.
- [8] G. M. Asher : The robust modelling of variable topology circuits using bond graphs, in: Proceeding of International Conference on Bond Graph Modelling, San Diego, CA, 1993, pp. 126-131.
- [9] J. Buisson : Analysis of switching devices with bond graph and characterisation of hybrid systems with bond-graphs, journal of the Franklin Institut vol 330, n°6, 1165-1175, November, 1993.
- [10] J. P. Ducreux, G. Dauphin-Tanguy and C. Rombaut. Bond graph modeling of commutation phenomena in power electronic circuits. In J. J. Granda and F. E. Cellier, editors, International Conference on Bond Graph modelling. ICBGM'93, Proc. of 1993 Western Simulation Multiconference, pages 264-269. SCS Publishing, January 17-20 1993. Simulation Series, Vol. 25, No. 2, ISBN:1-56555-019-6.
- [11] F. Lorenz : Discontinuities in bond graphs, what is required? ICBGM'93, SCS multiconference, San Diego, January, 1993.
- [12] P. J. Mosterman and G. Biswas: Behavior generation using model switching , a hybrid bond graph modelling technique,” Intrnational Conference on bond Graph modeling, pp. 177-182, 1995.

- [13] E. J. Manders, G. Biswas, N. Mahadevan, and G. Karsai, "Component-oriented modeling of hybrid dynamic systems using the Generic Modeling Environment," in Proceedings of the 4th Workshop on Model-Based Development of Computer Based Systems. Potsdam, Germany: IEEE CS Press, Mar. 2006.
- [14] I. Roychoudhury, M. Daigle, G. Biswas, X. Koutsoukos, and P. J. Mosterman, "A method for efficient simulation of hybrid bond graphs," in Proceedings of the International Conference on Bond Graph Modeling and Simulation, San Diego, California, 2007, pp. 177–184.

Taher Mekki received master's degree in electrical from high normal school technology education of Tunisia in 1995, the certificate of highest studies in specialty (CESS) in 2004, he is technologue in Higher Institute of Technological Studies of Gafsa. He is currently working toward the Ph.D degree in Research Unit on Renewable Energies and Electric Vehicles (RELEV), University of Sfax with co-direction of S. Triki and A. Kamoun from National School of Engineers of Sfax (ENIS), Tunisia.